

DS-2TP31B-3AUF

Body Temperature Measurement Camera



The handheld thermal camera, specially designed for body temperature measurement. It's equipped with a 160×120 resolution thermal detector. It helps to quickly detect fever

Key Features

- 160 × 120 resolution
- Thermographic accuracy up to ± 0.5 °C
- 320 × 240 resolution 2.4" LCD display
- Built-in rechargeable Li-ion battery
- Up to 8 hours continuous running

Functions

Thermography

Device detects the real-time temperature, and display it on the screen.

Storage

Device is equipped with replaceable memory card to store recorded captured snapshots, and important data.

Palette

Device supports 4 palettes.



Specification

		Model	DS-2TP31B-3AUF
Parameter		Handheld Thermography Camera	
Thermal Module	Image sensor	Uncooled Focal Plane Arrays	
	Max. Resolution	160 × 120	
	Pixel Pitch	17μm	
	Response waveband	8μm to 14μm	
	NETD	< 40mK (@ 25 °C,F#=1.0)	
	Field of View	37.2° × 50 °	
	Focal length	3.1 mm	
	IFOV (mrad)	5.48 mrad	
	Min. Focus Length	≥ 150 mm	
	Aperture	F 1.1	
Image Display	Monitor	320 × 240 resolution 2.4'' LCD display	
	Palettes	Black hot, White hot, Rainbow, Ironbow	
Thermography	Rules	3 thermometry points: Max. Temperature; Min. Temperature; Center Temperature	
	Thermographic Range	30°C to 45 °C	
	Thermographic Accuracy	±0.5 °C	
Battery	Battery Type	Rechargeable Lithium Battery	
	Battery Operating Time	8 hours continuous running	
Functions	Laser Light	Support (Point to the thermography target)	
	Storage	Replaceable memory card (default 8G, support up to 128G storage)	
	Photo	Thermal image	
	Video	N.A.	
	Language	English	
General	Power	3.7 V DC/0.4 A	
	Power Consumption	Less than 1.2 W	
	Hardware Interface	micro USB	
	Working Temperature	-10 °C to 50 °C (14 °F to 122 °F)	
	Protection level	IP54	
	Drop Test Height	2 m (6.56 feet)	
	Dimension	196 mm × 117 mm × 59 mm (7.7 " × 4.6 " × 2.3 ")	
	Weight	Approx. less than 350 g (0.77 lb)	
Accessory	Power Adaptor, USB cable, 8GB memory card, User manual, Disk, Wrist Strap		

Order Models
DS-2TP31B-3AUF

Box Content

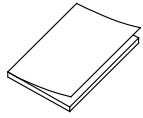

User Manual (×1)

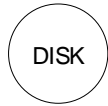

Disk (×1)

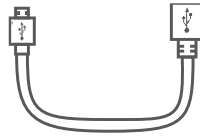

USB Cable (x1)

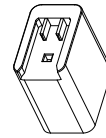

power Adapter
(x1)

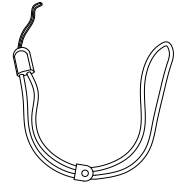

Wrist Strap (x1)

Dimension

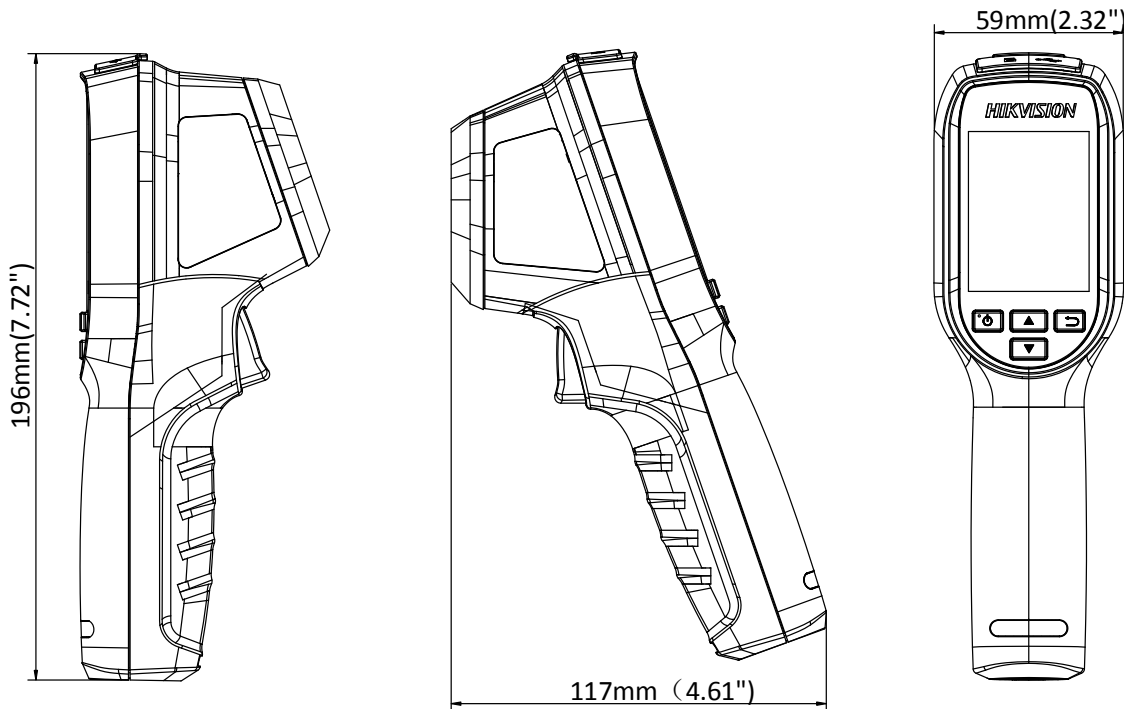

Distributed by

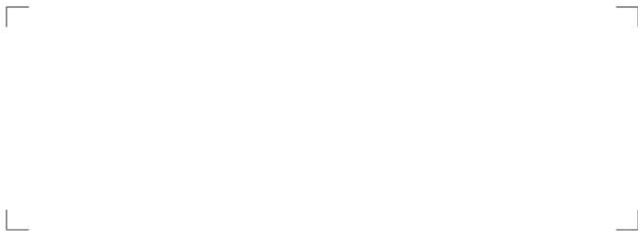

HIKVISION®

Headquarters

No.555 Qianmo Road, Binjiang District,
Hangzhou 310051, China
T +86-571-8807-5998
overseasbusiness@hikvision.com

Hikvision USA
T +1-909-895-0400
sales.usa@hikvision.com

Hikvision Australia
T +61-2-8599-4233
salesau@hikvision.com

Hikvision India
T +91-22-28469900
sales@pramahikvision.com

Hikvision Canada
T +1-866-200-6690
sales.canada@hikvision.com

Hikvision Thailand
T +662-275-9949
sales.thailand@hikvision.com

Hikvision Europe
T +31-23-5542770
sales.eu@hikvision.com

Hikvision Italy
T +39-0438-6902
info.it@hikvision.com

Hikvision Brazil
T +55 11 3318-0050
Latam.support@hikvision.com

Hikvision Turkey
T +90 (216)521 7070- 7074
sales.tr@hikvision.com

Hikvision Malaysia
T +601-7652-2413
sales.my@hikvision.com

Hikvision UK & Ireland
T +01628-902140
sales.uk@hikvision.com

Hikvision South Africa
Tel: +27 (10) 0351172
sale.africa@hikvision.com

Hikvision France
T +33(0)1-85-330-450
info.fr@hikvision.com

Hikvision Kazakhstan
T +7-727-9730667
nikia.panfilov@hikvision.ru

Hikvision Vietnam
T +84-974270888
sales.vt@hikvision.com

Hikvision UAE
T +971-4-4432090
salesme@hikvision.com

Hikvision Singapore
T +65-6684-4718
sg@hikvision.com

Hikvision Spain
T +34-91-737-16-55
info.es@hikvision.com

Hikvision Tashkent
T +99-87-1238-9438
uzb@hikvision.ru

Hikvision Hong Kong
T +852-2151-1761
info.hk@hikvision.com

Hikvision Russia
T +7-495-669-67-99
saleru@hikvision.com

Hikvision Korea
T +82-(0)31-731-8817
sales.korea@hikvision.com

Hikvision Poland
T +48-22-460-01-50
info.pl@hikvision.com

Hikvision Indonesia
T +62-21-2933759
Sales.Indonesia@hikvision.com

Hikvision Colombia
sales.colombia@hikvision.com